

CETONI

CE BASE 120 / 600

Hardware Manual



ORIGINAL INSTRUCTIONS 2.07 – MAY 2020

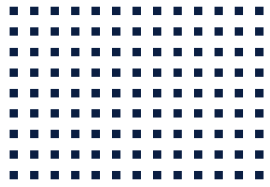

CETONI GmbH
Wiesenring 6
07554 Korbussen
Germany

T +49 (0) 36602 338-0

F +49 (0) 36602 338-11

E info@cetoni.de

www.cetoni.de

The information and data contained in this document are subject to change without notice. CETONI GmbH is constantly striving to develop all its products. This means that there may be changes in form, equipment and technology. Claims can therefore not be made on the basis of information, illustration or descriptions in these instructions. The description for the product specification in this manual does not constitute an integral part of the contract.

If you control the products with a software from CETONI GmbH, you agree to the applicable license agreement, which can be read in the corresponding software manual. This and all other current product manuals can be found at <https://www.cetoni.com/service/manuals>.

CETONI GmbH grants its customers the right to reproduce this manual for the purpose of providing technical information to potential users of CETONI products. Extracts of these documents may only be reproduced or transmitted with a precise reference to the authorship of CETONI GmbH, irrespective of the manner in which they are reproduced or transmitted, either electronically or mechanically. Any duplication or use of excerpts for other purposes requires the written permission of CETONI GmbH.

We are always open to comments, corrections and requests. Please send them to info@cetoni.de.

The general terms and conditions of CETONI GmbH shall apply. Alternative agreements must be in written form.

Copyright © CETONI GmbH – Automation and Microsystems. All rights reserved.

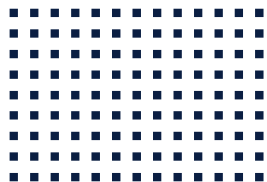

1 Overviews and Indexes

1.1 Content

1	Overviews and Indexes	5
1.1	Content	5
1.2	Change History	7
2	Introduction	8
2.1	Foreword	8
2.2	Symbols and Key Words Used	8
2.3	Norms and directives	9
2.4	General Description of the Device	9
2.5	Intended Use	9
2.6	Reasonably Foreseeable Faulty Application	9
2.7	Safety Advice	10
3	Scope of Supply	11
4	Base Module BASE 120	12
4.1	Hardware Operation	12
4.2	Technical Data	13
4.2.1	Mechanical Data	13
4.2.2	Electrical Data	13
4.2.3	Interfaces	13
4.2.4	Environment	13
5	Base Module BASE 600	14
5.1	Hardware Operation	14
5.2	Technical Data	16
5.2.1	Mechanical Data	16
5.2.2	Electrical Data	16

5.2.3	Interfaces	16
5.2.4	Environment	16
6	Extension Base Module BASE 600XT	17
6.1	Hardware Operation	17
6.2	Technical Data	18
6.2.1	Mechanical Data	18
6.2.2	Electrical Data	18
6.2.3	Ambient Conditions	19
6.3	In-Line System Extension	19
6.4	Off-Line Power Supply	20
7	Transportation and Storage	22
8	Maintenance and Care	23
9	Disposal	24

1.2 Change History

REV	DATE	CHANGE	VALID FOR
2.00	08.04.2015	Thematic splitting of the manual "Qmix hardware"	date of purchase after 08.04.2015
2.01	11.03.2016	New corporate design	date of purchase after 08.04.2015
2.03	24.05.2017	New image material for new design of BASE 120 and BASE 600	date of purchase after 08.04.2015
2.04	08.09.2017	Legal notice updated	date of purchase after 08.04.2015
2.05	17.09.2017	Updated title	date of purchase after 08.04.2015
2.06	15.01.2020	Scope of supply added for BASE120 and BASE600	date of purchase after 08.04.2015
2.07	04.05.2020	Updated Change History layout Added section Disposal	date of purchase after 08.04.2015



IMPORTANT. In its current revision, this manual applies only to the product types listed in the last line. Should you require a manual from a previous revision, please do not hesitate to contact us. Please let us know your device type and email address and we will send you the appropriate manual as a pdf file.

The type of your product can be found on the label behind "Type:" according to the marked number in the following example:

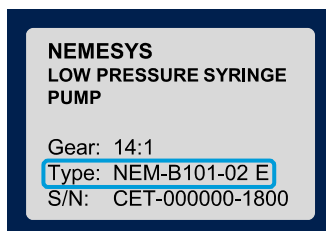

2 Introduction

2.1 Foreword

Thank you for purchasing a product from CETONI. With this user manual we would like to support you as well as possible when handling the device. If you have any questions or suggestions, please do not hesitate to contact us.

2.2 Symbols and Key Words Used

The following symbols are used in this manual and are designed to aid your navigation through this document:



HINT. Describes practical tips and useful information to facilitate the handling of the software.



IMPORTANT. Signifies important hints and other useful information that may not result in potentially dangerous or harmful situations.



ATTENTION. Indicates a potentially harmful situation. If it is not avoided, the product or something in its environment may be damaged.



CAUTION. Indicates a potentially dangerous situation. If it is not avoided, slight or minor injuries and property damage may result.

2.3 Norms and directives



CETONI GmbH declares under its sole responsibility, that the device complies with the health and safety requirements of the relevant European directives.

2.4 General Description of the Device

The Qmix base modules BASE 120, BASE 600 und BASE 600XT are used to supply the Qmix modules with a supply voltage of 24V. BASE 120 and BASE 600 also provide a USB interface for connection to a PC.

2.5 Intended Use

The Qmix base modules BASE 120, BASE 600 und BASE 600XT are to be used for the appropriate CETONI GmbH laboratory devices. Application usually takes place in laboratory-like rooms.

2.6 Reasonably Foreseeable Faulty Application

A use for applications distinct from the intended purpose can lead to dangerous situations and is to be omitted.



CAUTION. The unit must not be used as a medical device or for medical purposes.

2.7 Safety Advice

For the safe operation of a base module, it is essential to observe the safety measures in the CETONI System manual.



IMPORTANT. Please read this manual as well as the related software manual carefully and completely before putting your Qmix system into operation.

Additionally please read the CETONI System manual carefully and completely before putting your system into operation.

3 Scope of Supply

The delivery of the BASE120 and BASE600 should include the following items in addition to the unit itself (does not apply to BASE600 XT):

COUNTRY SPECIFIC POWER CABLE FOR NON-HEATING APPARATUS



USB CABLE



BUS TERMINATING PLUG



HARDWARE-MANUAL AND CD WITH SOFTWARE-MANUAL, SOFTWARE AND DRIVERS



4 Base Module BASE 120

4.1 Hardware Operation

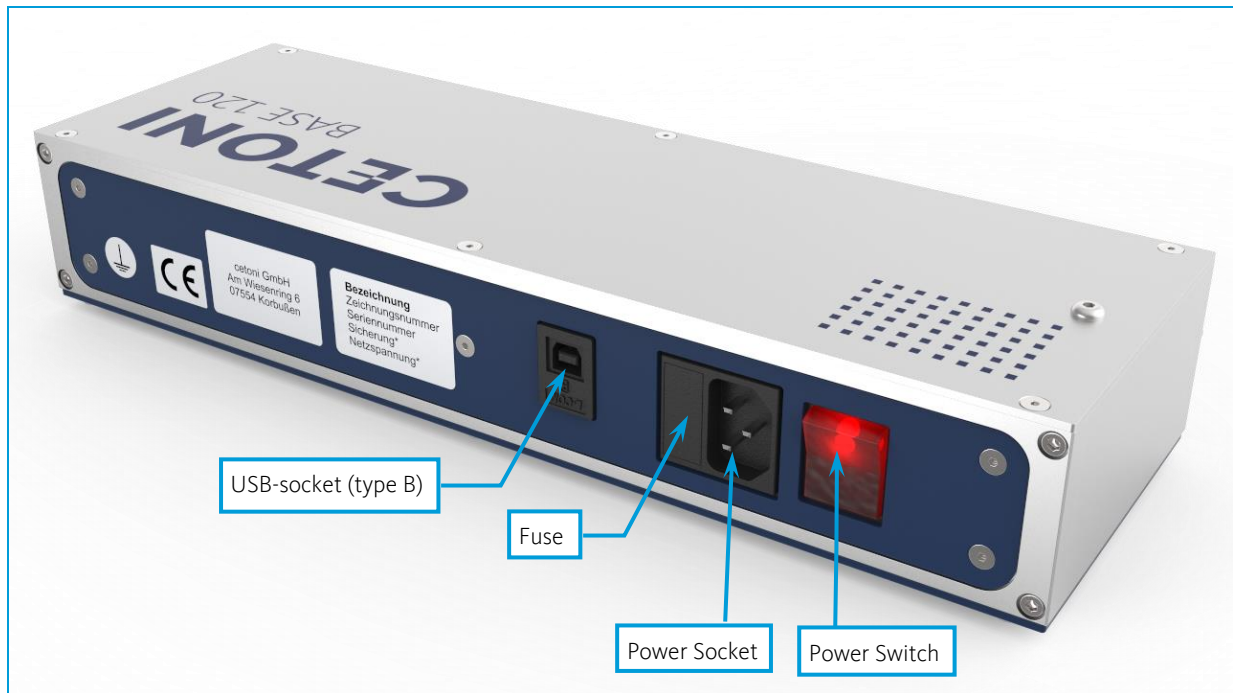

The base module supplies all other modules with power and serves as an interface to your PC.

The BASE 120 base module can continuously supply a power of 120 W. In the section *technical data* → *electrical data* you can find the power consumption of every module you may want to connect. Please make sure that the total power consumption of the assembly must not exceed the power supply capability of the base module. In case of overload the base module will deactivate itself and all connected devices and you will lose control of your application.

Should the power supply capacity of the BASE 120 base module be insufficient, you may also use the BASE 600 base module or the BASE 600XT extension.



CAUTION. Danger of sudden deactivation! Make sure that the total power consumption of all connected devices does not exceed the power supply capacity of the base module.

On one side of the device there is a power connector with a fuse box. A replacement fuse (Ø5x20mm) can be found in the same box. The rated current of the fuse may vary depending on the country of use and can be seen on the type plate.

The power switch is located to the right of the power socket and will light up red when the device is turned on. The type B USB-connector is used to connect the device to your PC.

4.2 Technical Data

4.2.1 Mechanical Data

DIMENSION (L X B X H)	310 x 100 x 56 mm
WEIGHT	≈1800 g

4.2.2 Electrical Data

SUPPLY VOLTAGE	90 ~ 260VAC
FREQUENCY	47 ~ 63 Hz
POWER OUTPUT	24VDC; 5A; 120 W

4.2.3 Interfaces

USB	1.1 und 2.0
------------	-------------

4.2.4 Environment

OPERATING TEMPERATURE	0°C to 50°C
STORAGE TEMPERATURE	-20°C to 75°C
OPERATING / STORAGE AIT HUMIDITY	20% to 90%, non-condensing

5 Base Module BASE 600

5.1 Hardware Operation

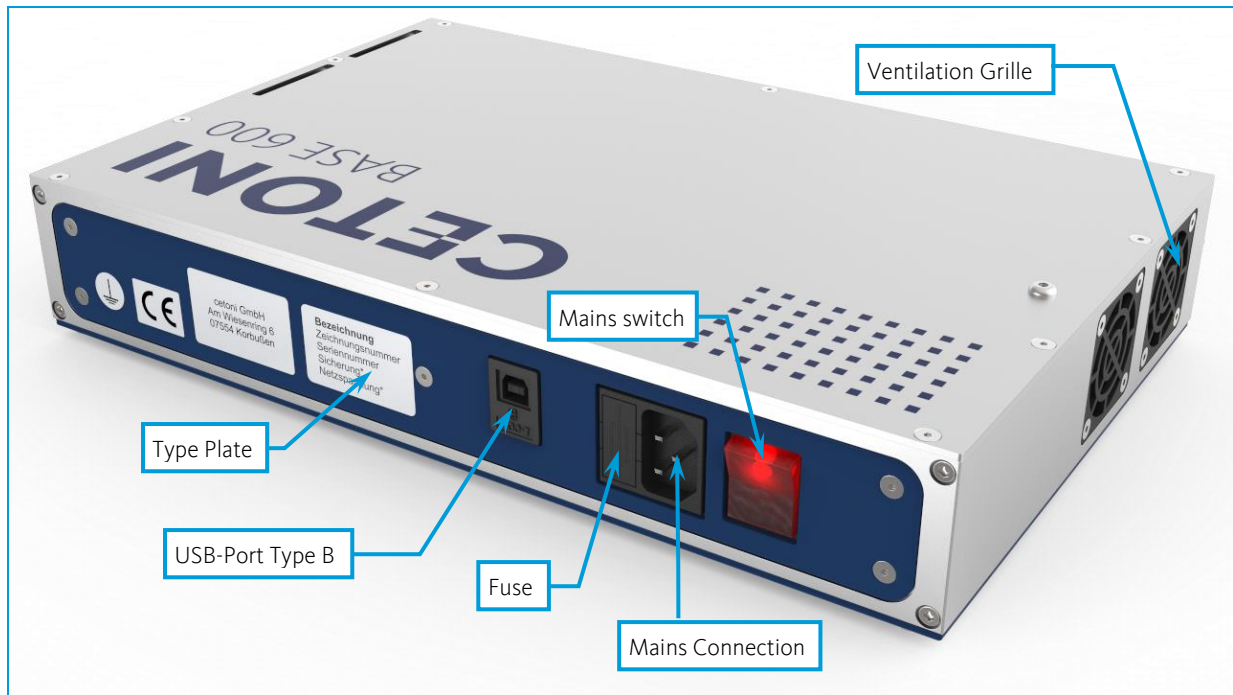

The Base Module supplies all connected modules with electricity and serves as an interface to your PC.

The Qmix Base Module can provide a maximum power output of 650W permanently. For any module you connect, the power consumption value can be found in the section *Technical Data* → *Electrical Data*. Please observe that the total power consumption of all connected modules does not exceed the power output of the Base module. The Base module and all connected Modules will switch off in the event of an overload and you will no longer have the control over your application.

Instead of the Qmix Base Module you can also use the smaller NEMESYS Base module, which has a maximum power output of 120W.



CAUTION. Risk of sudden shut down! Observe that the total power consumption of all connected modules does not exceed the power output of the Base module.

The mains connection including the fuse compartment is located on the side of the device. A replacement fuse (Ø5x20mm) can be found in the same compartment. The rated current of the fuse can vary between countries and is specified on the type plate.

The mains switch is located to the right of the mains connection. It will light up red when the device is connected and switched on.

The USB-port (type B) is used to connect the Qmix system with your PC.

Pay attention not to cover the ventilation grilles. Otherwise the device might switch off to avoid damage due to overheating. This would happen unexpectedly and without an advance warning.

On one side there are additional ventilation slots on the base plate of the device. The ventilation grilles on this side may be covered, for instance for upright use, as long as the ventilation slots allow free air flow (as shown in the following picture).



5.2 Technical Data

5.2.1 Mechanical Data

DIMENSION (L X B X H)	310 x 200 x 56 mm
WEIGHT	≈3700 g

5.2.2 Electrical Data

SUPPLY VOLTAGE	90 ~ 260VAC
FREQUENCY	47 ~ 63 Hz
POWER OUTPUT	24VDC; 27A; 650 W

5.2.3 Interfaces

USB	1.1 und 2.0
------------	-------------

5.2.4 Environment

OPERATING TEMPERATURE	0°C to 50°C
STORAGE TEMPERATURE	-20°C to 75°C
OPERATING / STORAGE AIT HUMIDITY	20% to 90%, non-condensing

6 Extension Base Module BASE 600XT

6.1 Hardware Operation



The Extension Base Module is used if the power of the normal Base Module is not sufficient to feed your entire system with energy. It also provides a maximum power of 650 W.

For any module you connect, the power consumption value can be found in the section *Technical Data* of the appropriate manual. Please observe that the total power consumption of all connected modules does not exceed the power output of the Extension Base Module. The Extension Base Module and all connected Modules will switch off in the event of an overload and you will no longer have the control over your application.



CAUTION. Risk of sudden shut down! Observe that the total power consumption of all connected modules does not exceed the power output of the Base module.

The Extension Base Module can only be operated in connection with an existing system. It automatically turns on and off with this.

The connections of the Extension Base Module are explained below:



NO.	DESCRIPTION
1	Mains connection with fuse (Ø5x20mm see type plate)
2	Connector for connection to the base system via Interconnect cable
3	Display for the current power output (650W max.)
4	Three connectors for off-line loads (450W max. per connector)
5	Connector for additional modules (on opposite side)

6.2 Technical Data

6.2.1 Mechanical Data

DIMENSIONS (L X B X H)	310 x 200 x 56 mm
WEIGHT	≈3700 g

6.2.2 Electrical Data

SUPPLY VOLTAGE	90 ~ 264VAC
-----------------------	-------------

FREQUENCY	47 ~ 63 Hz
POWER OUTPUT	24VDC; 27A; 650 W

6.2.3 Ambient Conditions

OPERATING TEMPERATURE	0°C to 50°C
STORAGE TEMPERATURE	-20°C to 75°C
OPERATING / STORAGE AIT HUMIDITY	20% to 90%, non-condensing

The extension base module can be used in two different ways, which are explained below:

6.3 In-Line System Extension

In the case of in-line system extension, the Extension Base Module is connected to an existing base system via an interconnect cable. Now additional modules can be connected to the Extension Base Module as usual (see general part of the manual, section “Connection of additional modules”). The entire system is controlled by the PC, which is connected to the Base Module of the base system. The Extension Base Module automatically switches on and off together with the Base Module of the base system.

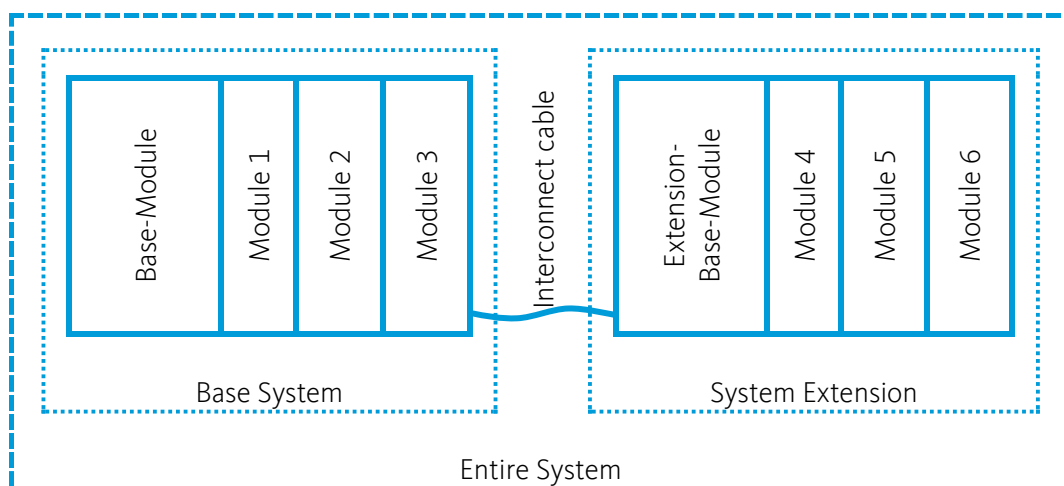

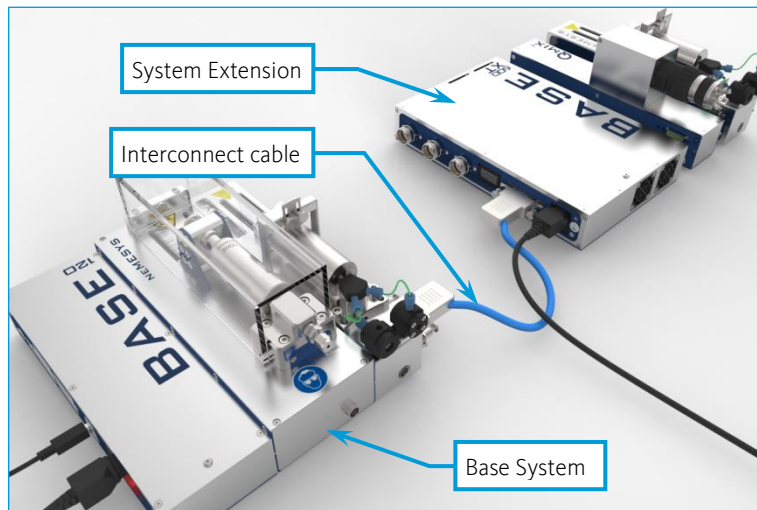

Simply connect the last module of your base system to the corresponding connector of the Extension Base Module via the interconnect cable. Furthermore connect it to the mains supply.

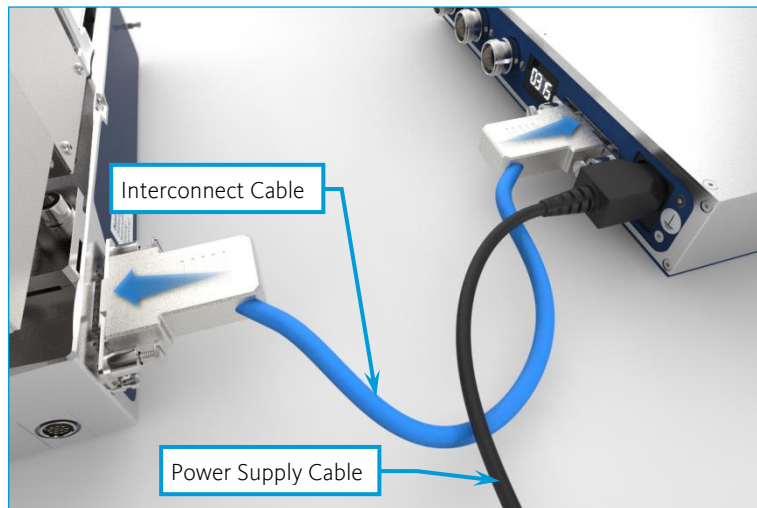

6.4 Off-Line Power Supply

When used Off-Line, at most three devices can be supplied with power by the Extension Base Module. Only devices with potentially high power consumption, which are equipped with the appropriate connector, can be connected Off-Line. All other devices of the base system are still supplied with power by the Base-Module of the base system. The Off-Line use is explained below using the example of the temperature control module Qmix TC.

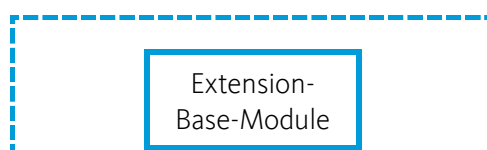

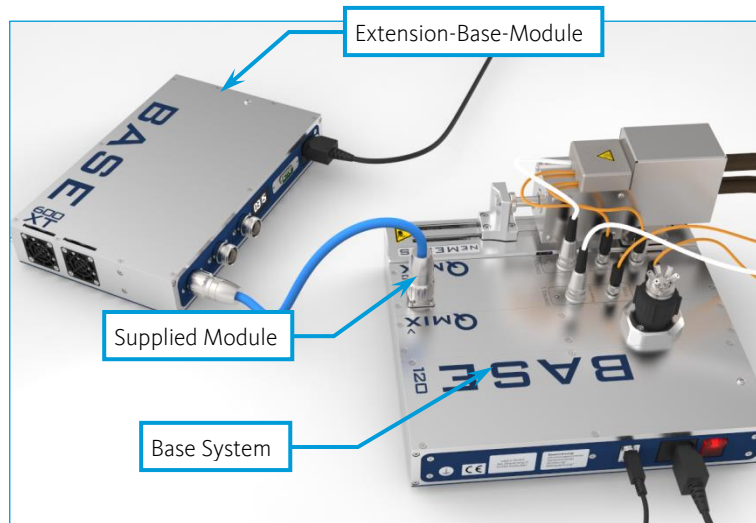
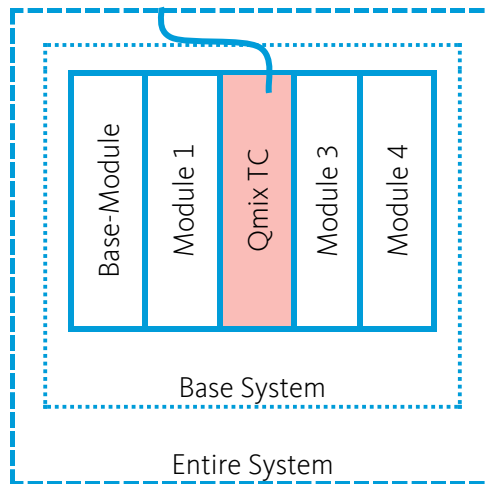

Plug the cable connectors of the connecting cable to corresponding connectors of the Extension-Base-Module and the module to be supplied and slightly tighten the union nuts.

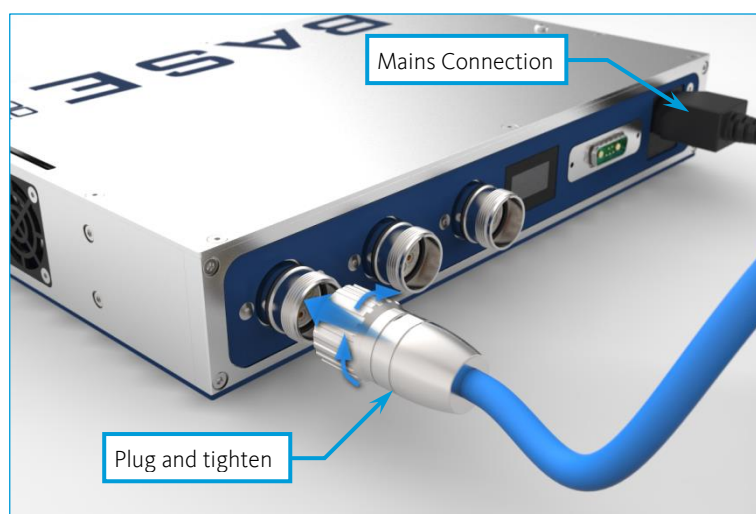

7 Transportation and Storage

Please do not lift and transport the modules in the plugged-together state. Transport in the plugged-together state only permitted in the original packaging.

Use the original packaging for transport and shipping of the modules.

Observe the specifications in chapter "Technical data" for storage.



CAUTION. Risk of damaging the device. Do not transport the modules plugged-together.

8 Maintenance and Care

If used in accordance with intended purpose, the device is maintenance-free. Should there be a failure despite this, which you cannot eliminate yourself, or which requires opening the device, please contact CETONI GmbH to coordinate further actions. The device may only be opened by CETONI GmbH or thereby authorized service staff. Otherwise the warranty and guarantee claims are void.

Software-related troubles are dealt with in the Software Manual.

For cleaning it please rub the surface gently with a soft, damp cloth. The cloth must not be wet, so that no fluency can trickle into the device. In case of a heavier soiling you can also use a little bit of detergent or alcohol.

9 Disposal

Please send your old devices back to CETONI GmbH. We will take care of proper disposal.

If necessary, please decontaminate the device before sending it back and attach a completed decontamination declaration with your shipment.