

CETONI

CE QMIX λ Hardware Manual

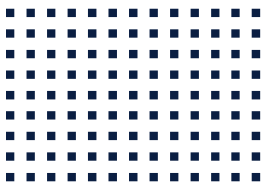

ORIGINAL MANUAL 3.00 – FEBRUARY 2016



CETONI GmbH
Wiesenring 6
07554 Korbussen
Germany

T +49 (0) 36602 338-0
F +49 (0) 36602 338-11
E info@cetoni.de

www.cetoni.de

Software license

The software and the documents provided are protected by copyright. Installation declares your acceptance of the conditions of the licensing contract.

License agreement

CETONI GmbH grants the purchaser the non-exclusive and non-transferable license right to use the software on a standalone computer or a networked computer system (LAN). It is expressly forbidden to copy or duplicate the software in part or in whole in any way. The same applies to mixing and combining the software with other software. The purchaser may create one back-up copy of the software for archival purposes. CETONI GmbH reserves the right to alter, develop and improve the software or develop new software to replace it. CETONI GmbH is not obliged to inform the purchaser of any alterations, new developments or improvements to the software or make these available to him. No legally binding assurance of certain features is given. CETONI GmbH is not liable for damages unless the damages are as a result of wilful intent or gross negligence on the part of CETONI GmbH or its employees. Any liability for indirect, collateral, or consequential damages is excluded.

The information and data contained in this documentation can be amended without notice. The reproduction, distribution and utilization of this document as well as the communication of its contents to others without explicit authorization is prohibited. Offenders will be held liable for the payment of damages. All rights reserved in the event of the grant of a patent, utility model or design. The general terms and conditions of CETONI GmbH apply. Alternative agreements must be in written form.

Copyright © CETONI GmbH – Automation and Microsystems. All rights reserved.

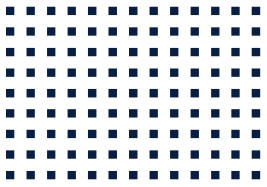

1 Summaries and directories

1.1 Table of contents

1	Summaries and directories	5
1.1	Table of contents	5
1.2	Change history	6
2	Scope of supply	7
3	Technical data	8
3.1	Environment	8
3.2	General data	8
3.3	Electrical data	8
3.4	Interfaces	8
3.5	Wetted parts	9
4	Use	10
4.1	General description of the device	10
4.2	Intended use	10
4.3	Reasonably foreseeable faulty application	10
4.4	Safety advice	10
5	Transportation and storage	11
6	Operation	12
6.1	(Dis)Assembly of the measuring cell	13
6.2	Fluidic connection	16
6.3	Light source	16
6.4	Changing the light source (small module)	17
7	Maintenance and care	19

1.2 Change history

REV	DATE	CHANGES
1.00	18.12.2015	First version of Qmix hardware manual
1.01	05.02.2013	Various minor changes
1.10	12.09.2013	Added Qmix BaseXT and TC, power consumption Q+
1.11	21.08.2014	Adaptation of the maximum heating temperature of the Reaction module Q+ heating column and the High temperature T-mixer due to material changes.
2.00	18.08.2015	Separation into module-specific manuals
3.00	23.02.2016	New flow measuring cell, new design

2 Scope of supply

The following items should be included in the scope of supply:

QMIX λ MODULE

- Spectrometer as ordered
- Light source as ordered



OCEANVIEW SPECTROSCOPY APPLICATION:



MANUAL HARDWARE



3 Technical data

3.1 Environment

OPERATING TEMPERATURE	0°C ~ 50°C
STORAGE TEMPERATURE	-20°C ~ 70°C
OPERATING HUMIDITY	20% ~ 90%, non-condensing
STORAGE HUMIDITY	20% ~ 90%, non-condensing

3.2 General data

DIMENSIONS (L X W X H)	310 x 75 x 90/100 mm
WEIGHT	0.9 kg / 1.1 kg
WAVELENGTH RANGE	Depending on the configuration
MAXIMUM PRESSURE	10 bar

3.3 Electrical data

POWER CONSUMPTION	(supplied via USB)
--------------------------	--------------------

3.4 Interfaces

FLUIDIC	10-32 UNF coned; 1/16" tubing
LIGHT SOURCE	SMA 905
DATA	USB 2.0 Type B

3.5 Wetted parts

WINDOW	fused silica (SiO ₂)
LIGHT SOURCE	PPS (polyphenylene sulfide)
MEASUREMENT SECTION	PTFE (tubing)
SEALS	FPM

4 Use

4.1 General description of the device

The Qmix λ modules are a part of the Qmix micro reaction and analysis system. They allow the spectral analysis of fluids in flow.

4.2 Intended use

The Qmix λ modules serve the spectral analysis of fluids in flow. They are intended only to be used in a Qmix micro reaction system from CETONI GmbH. The application is usually carried out in laboratory-like rooms.

4.3 Reasonably foreseeable faulty application

A use for applications distinct from the intended purpose can lead to dangerous situations and is to be omitted.



CAUTION. The unit must not be used as a medical device or for medical purposes!

4.4 Safety advice

For the safe operation of the Qmix λ modules it is necessary to observe the safety measures from the general section of the manual for the Qmix micro reaction system. Take into account particularly the remarks regarding the European Pressure Equipment Directive 2014/68/EU.



IMPORTANT. Please read this manual, the general part for the Qmix system, as well as the related software manual carefully and completely before putting your Qmix λ module into operation.

When using an external light source, please read the associated manual carefully and completely before putting the light source into operation. Pay particular attention to the safety instructions contained therein.

5 Transportation and storage

The individual modules must not be lifted or transported plugged-together. Transportation of plugged-together devices is only allowed in the original packaging.

Use the original packaging for transportation or shipping of the module.

Concerning the storage conditions, please observe the data from chapter “Technical data”.



CAUTION. Risk of damaging the device. Do not transport the modules plugged-together.



CAUTION. Transportation, storage or operation of the modules below 0°C with water in the fluid passages may cause damage to the module.

6 Operation

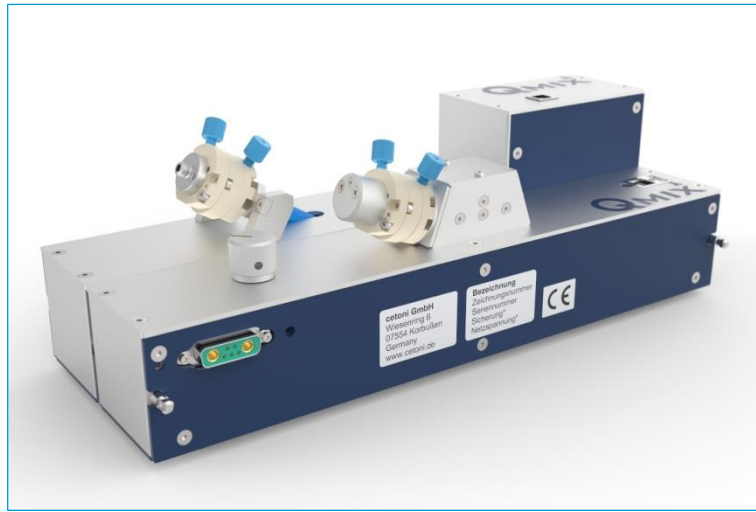

The Qmix λ modules allow performing a spectral analysis of fluids within a flow measuring cell of variable length.

The installation and handling of the spectrometer are described in the related spectrometer manual. This can be found on the supplied CD. Read this manual and follow the instructions it gives, before connecting the module to your system.

The two Qmix λ modules differ in the used spectrometer and in the light source. The smaller module, depending on the configuration, covers a wavelength range of 350 to 1100nm. It provides an integrated LED light source, which can be adapted to the required wavelength range. An adapter with SMA 905 connector is also available.

The larger module can be adapted for best performance in a wavelength range from 200 to 1100nm. Any external light source can be connected via an SMA 905 connector.

To compensate the influence of differing optical density, both modules incorporate a flow measuring cell of variable length. The functionality of the flow measuring cell is shown in the following cross section drawing. The intermediate piece which is slightly darker in the picture can be exchanged and is available in three different lengths. This results in measurement sections of 8, 16 and 32mm length.

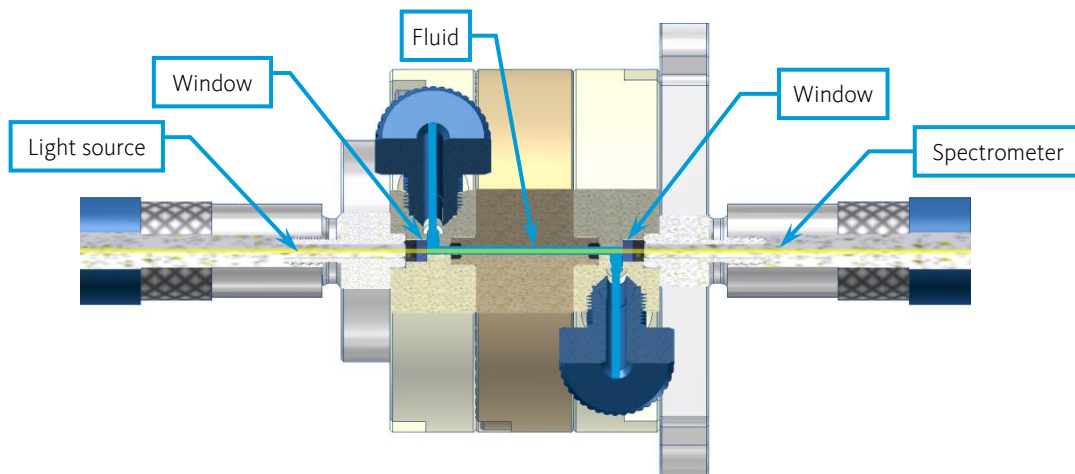

CAUTION. Check chemical resistance of the wetted parts against the used chemicals before using the device.



CAUTION. The flow measuring cell is suitable for a maximum operating pressure of 10 bar. Make sure that the tubing, you want to use, is also suitable for the expected pressure.



CAUTION. Depending on the configuration of the internal or an external light source optical radiation may leak, that can cause eye and skin damage. Note the safety information concerning wavelength and optical power. When using an external light source read the associated manual of the manufacturer and follow the safety instructions therein.

6.1 (Dis)Assembly of the measuring cell

Both Qmix λ modules have a holder for the measuring cell. The only functional difference is the presence of spring contacts on the small which serve to power the LED light source.

The measuring cell consists of the same parts on both Qmix λ modules - two connection pieces and an intermediate piece. The assembly of the measuring cell on the devices will be described below.

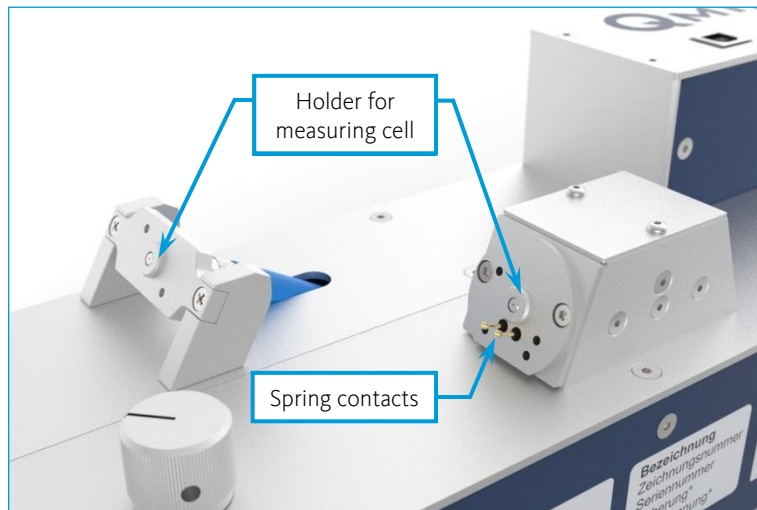

Place the window followed by the O-ring in the central recess of one of the connection pieces. If the window is provided with an anti-reflective coating on one side, the window has to be placed with this side first.

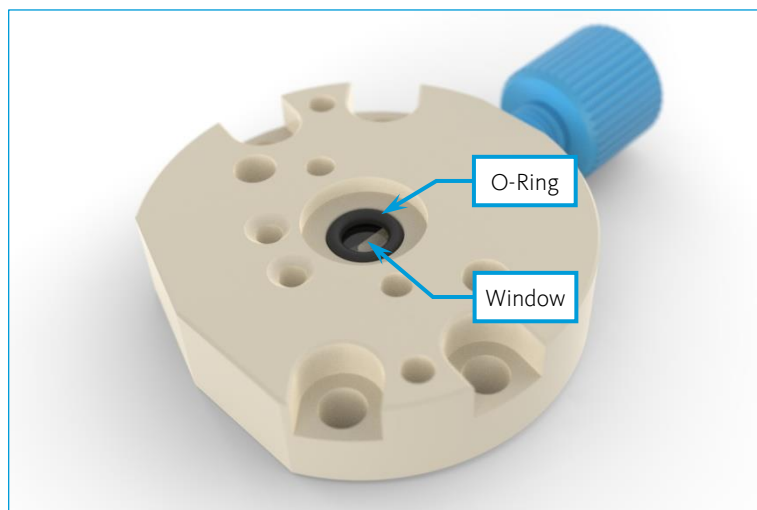

Attach the connection piece to the holder on the module with two M2.5x8 screws using a 2 mm Allen key. It may be helpful to hold the module upright, lest the window and the O-ring fall out.

At the small module, the spring contacts protrude through the connection piece.

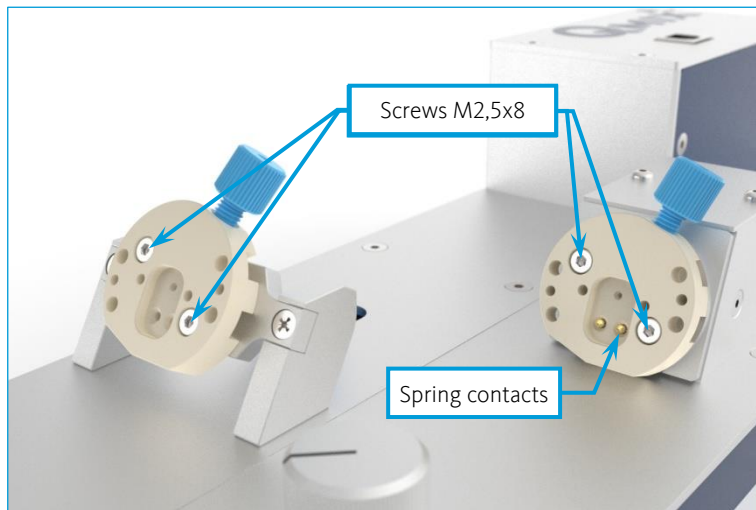

The intermediate piece is mounted next. The shortest intermediate piece is simply inserted into the recess of the connection piece ①. The two longer intermediate pieces are attached with the corresponding screws (M2.5x10 or M2.5x25) using a 2mm Allen key ②.

Make sure that O-Rings are mounted in the recesses of the intermediate piece on both sides. The PTFE tubing can be used optionally.

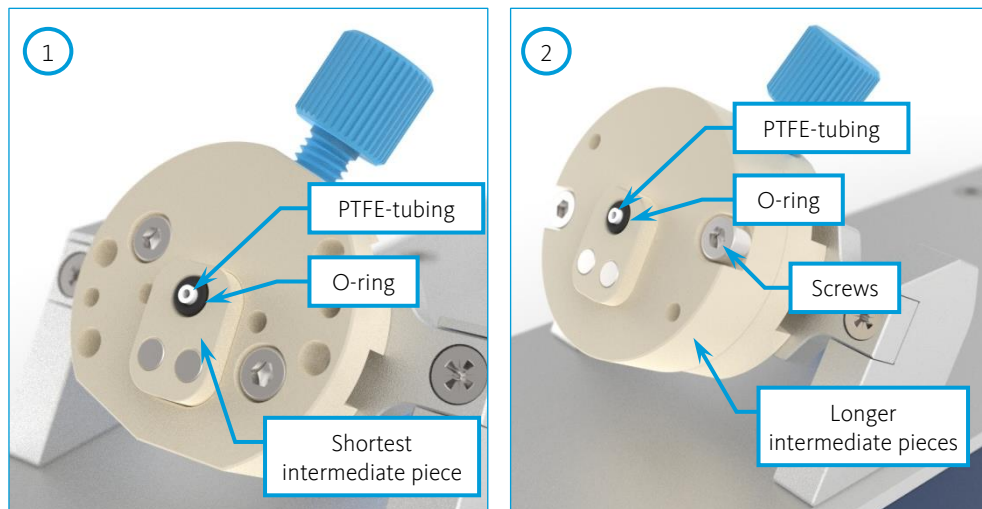

Finally the second connection piece is mounted. When the shortest intermediate piece is used, the final connection piece is screw mounted directly on the existing connection piece ①. When one of the longer intermediate pieces is used, the final connection piece is screw mounted to this ②. Use the corresponding M2.5x10 screws therefore.

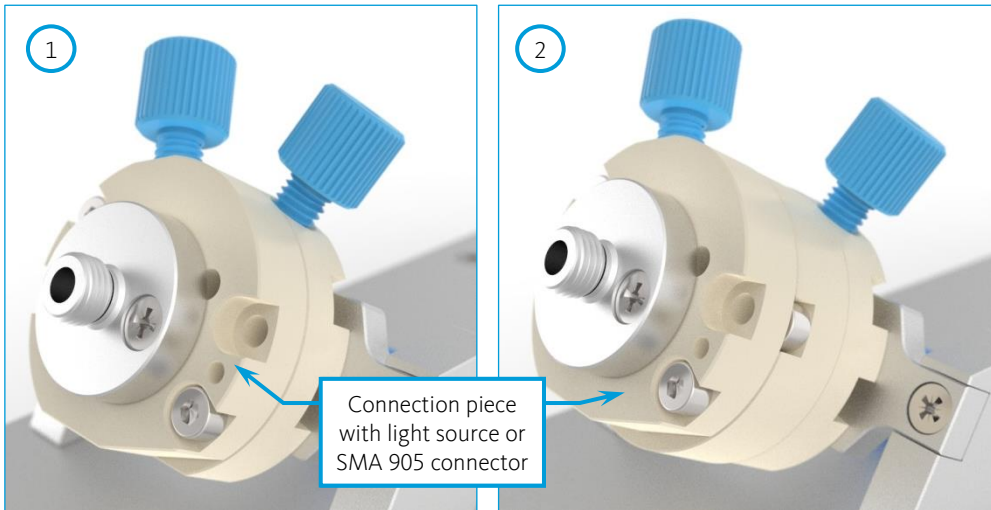

6.2 Fluidic connection

The fluidic connection of the measuring cell is achieved with 1/16" tubing and coned 10-32 UNF fittings (for instance IDEX F-120).

The direction of flow through the measuring cell does not matter. So it is your decision which of the ports you would like to be in- or outlet.

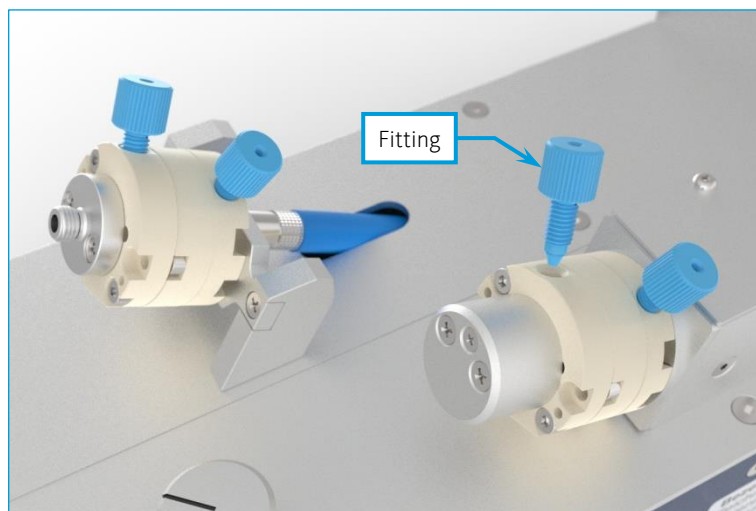

6.3 Light source

The small module provides an integrated LED light source. The brightness of the LED can be adjusted to your needs with the dial on the device. An adapter with SMA 905 connector for use of external light sources is available optionally.

The larger module is equipped with the SMA 905 connector by default. Insert the fiber of the external light source into the connector and tighten the union nut.

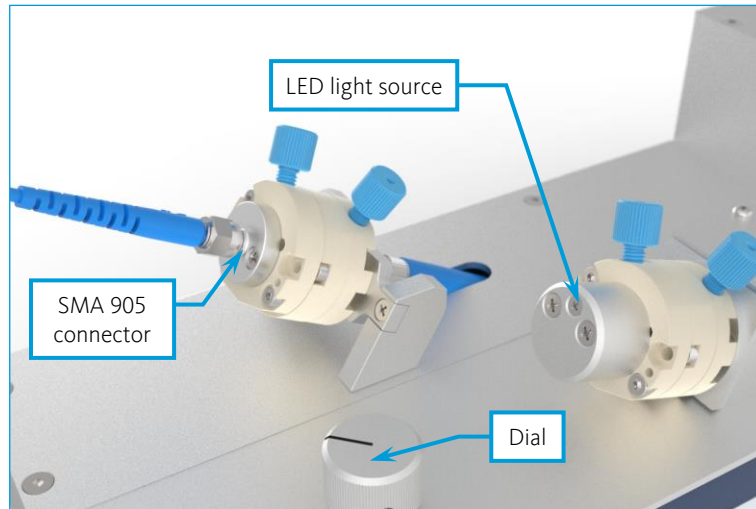

6.4 Changing the light source (small module)

You can replace the LED attachment, for example in order to change the wavelength of the emitted light. To do this, remove the two marked screws with a phillips screwdriver and then simply exchange the LED attachment. Please do not remove the smaller screw in the centre.

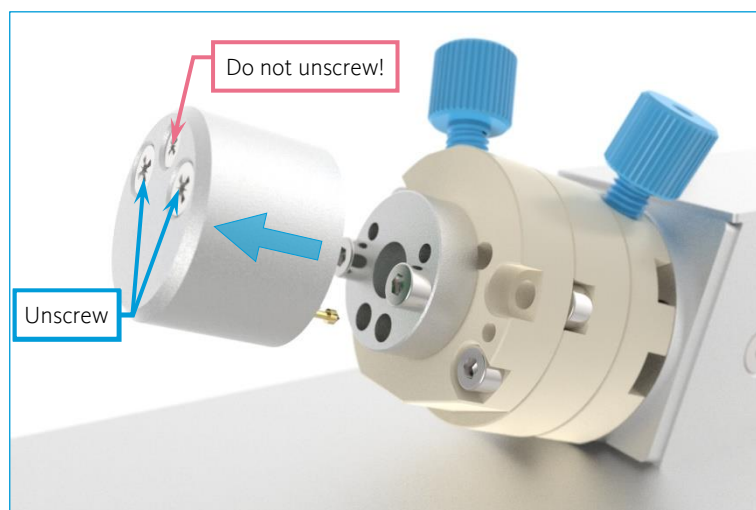

If you want to mount the SMA 905 adapter instead of the LED light source, remove the two screws with a 2 mm Allen key and then pull out the mounting plate. Make sure that the window and the O-ring remain in the central recess of the connection piece. Now you can plug in the SMA 905 adapter and fasten it with the accompanying Phillips screws.

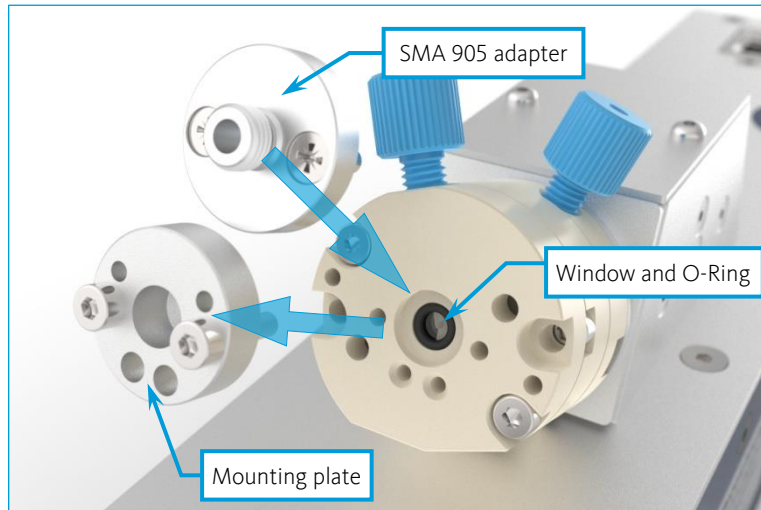

7 Maintenance and care

If used in accordance with intended purpose, the device is maintenance-free. Should there be a failure despite this, which you cannot eliminate yourself, or which requires opening the device, please contact CETONI GmbH to coordinate further actions. The device may only be opened by CETONI GmbH or thereby authorized service staff. Otherwise the warranty and guarantee claims are void.

Software-related troubles are dealt with in the Software Manual.

For cleaning it please rub the surface gently with a soft, damp cloth. The cloth must not be wet, so that no fluency can trickle into the device. In case of a heavier soiling you can also use a little bit of detergent or alcohol.